

APPLICATION

Fully lugged ductile iron Butterfly Valve with bonded EPDM liner and stainless steel trim, fitted with gear operator for infinitely variable settings and stainless steel memory stop feature (DRV) to precisely set and retain the desired maximum opening position differential pressure. Once set, the valve can be closed and re-opened accurately to the pre-set differential pressure.

Commercially attractive option compared to traditional Globe-style Double Regulating Valves. Space saving and easier to support when weight is a concern. Available in large sizes up-to and including 600mm diameter. To measure ΔP , Pressure/Temperature plugs are to be installed in the pipework on either side of the valve.

SPECIFICATION

Body:	Ductile Iron
Disc, Pin & Stem:	Stainless Steel
Seat:	Vulcanised EPDM
Operation:	Gearbox in Ductile Iron
Coating:	RAL 5015 (thickness 250 micron)
Standard:	BS EN 593
Dimensions:	Face-to-Face BS EN 558 (series 20)
Type:	<ul style="list-style-type: none"> • Drilling: PN16 • Shaft: SS AISI 431 • Thread: Metric
Tests:	Inspected acc. to BS EN 12266-1 & European PED #2014/68/EU, 15/05/2014, CE marked
Size:	Standard 65mm—600mm
Temperature Range:	-15 to 120 °C
Max. Working Pressure:	16 Bar

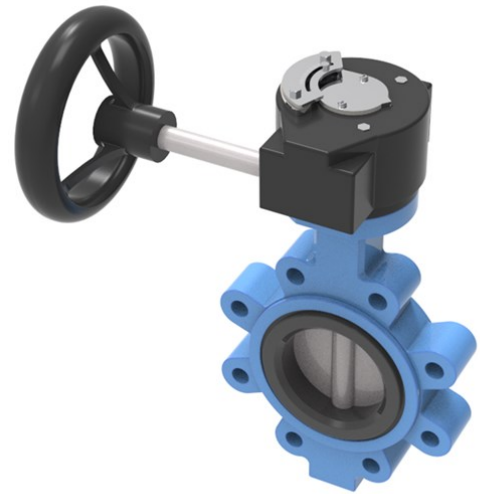

FEATURES AND BENEFITS

- Robust ductile iron Butterfly Valve for long service life
- Easy to install and operate fully lugged gear operated Butterfly Valve
- Easy to set, positive position and reset memory stop feature
- Light weight and low cost
- Smaller [40/50mm] and larger [700/800mm] sizes available on request

PRODUCT CODES AND DIMENSIONS

Product Code	Size (DN)	H*	H1*	H3*	ØD2	N-M	C*	F*	ØV-V*	Kg	OTV (N.m)	BTV (N.m)	Gearbox		
													OT N-M	Ratio	N° of turns
LUGN50065MDVEPV1623DRV	65	140	94	-	145	4-M16	65	154	135	10.8	17.2	86	200	24:1	6
LUGN50080MDVEPV1623DRV	80	145	105	-	160	8-M16	65	154	135	11.4	23.1	86	200	24:1	6
LUGN50100MDVEPV1623DRV	100	160	126	-	180	8-M16	65	154	135	15	39.8	169	200	24:1	6
LUGN50125MDVEPV1623DRV	125	170	140	-	210	8-M16	65	154	135	19.3	61.9	291	200	24:1	6
LUGN50150MDVEPV1623DRV	150	190	151	-	240	8-M16	65	154	135	19	102	291	200	24:1	6
LUGN50200MDVEPV1623DRV	200	220	183	-	295	12-M20	77	225	285	27.5	192	465	500	32:1	8
LUGN50250MDVEPV1623DRV	250	260	217	-	355	12-M24	77	225	285	45.5	323	993	500	32:1	8
LUGN50300MDVEPV1623DRV	300	290	252	-	410	12-M24	80	215	285	61.7	490	1360	1200	50:1	12.5
LUGN50350MDVEPV1623DRV	350	320	285	-	470	16-M24	80	215	285	67.5	625	1360	1200	50:1	12.5
LUGN50400MDVEPV1623DRV	400	356	315	271	525	16-M27	121	256	285	102	846	2356	2.5x103	560:1	140
LUGN50450MDVEPV1623DRV	450	387	384	271	585	20-M27	121	256	285	153	1131	3394	2.5x103	560:1	140
LUGN50500MDVEPV1623DRV	500	424	390	271	650	20-M30	121	256	285	208	1431	4120	2.5x103	560:1	140
LUGN50600MDVEPV1623DRV	600	524	455	330	770	20-M33	130	285	385	320	2301	6781	4x103	506:1	140

*Dimensions are in mm. OTV: Operation Torque Value. BTV: Breaking Torque Value. Precise gear box measurements are available in the component data sheets.

DN 65 - 350

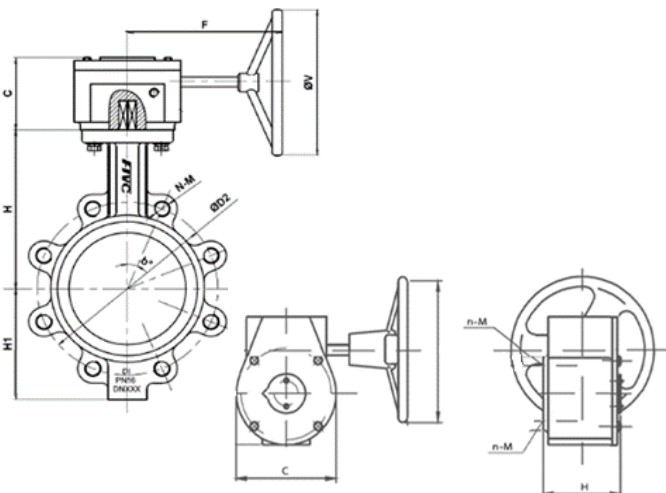

DN 400-600

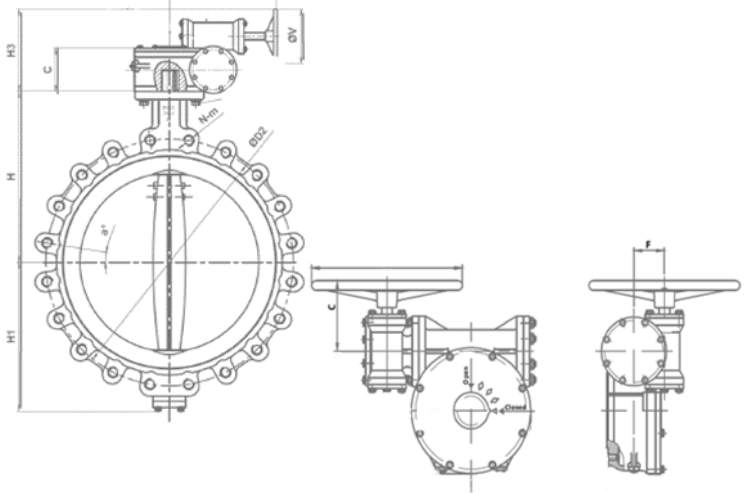

SELECTIONS

65mm Butterfly Valve Double Regulating Butterfly Valve
 Flow range: 1.0 – 19.0 l/s
 ΔP range: 1.0 – 12.0 Kpa

80mm Butterfly Valve Double Regulating Butterfly Valve
 Flow range: 2.0 – 30.0 l/s
 ΔP range: 1.0 – 12.0 Kpa

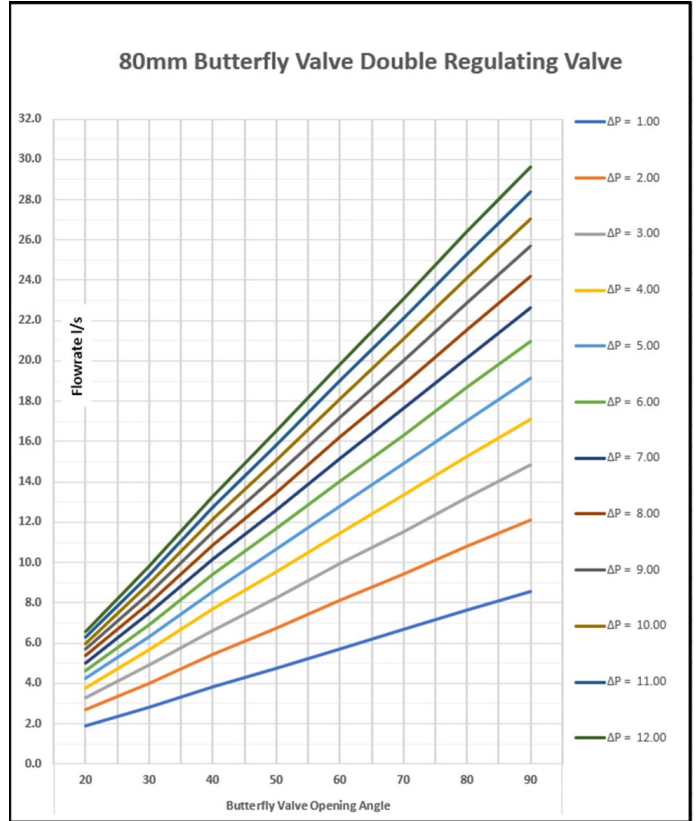
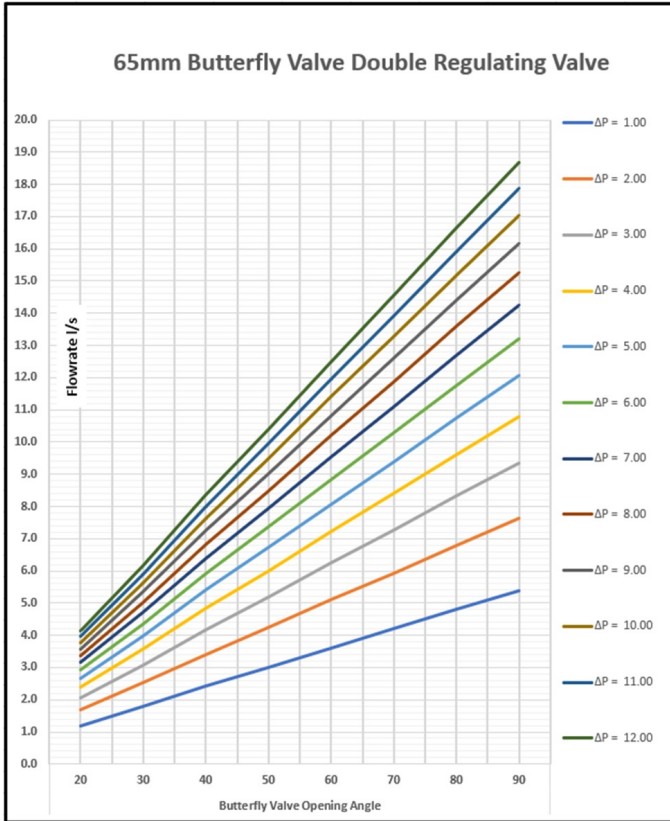

100mm Butterfly Valve Double Regulating Butterfly Valve
 Flow range: 3.0 – 54.0 l/s
 ΔP range: 1.0 – 12.0 Kpa

125mm Butterfly Valve Double Regulating Butterfly Valve
 Flow range: 5.0 – 87.0 l/s
 ΔP range: 1.0 – 12.0 Kpa

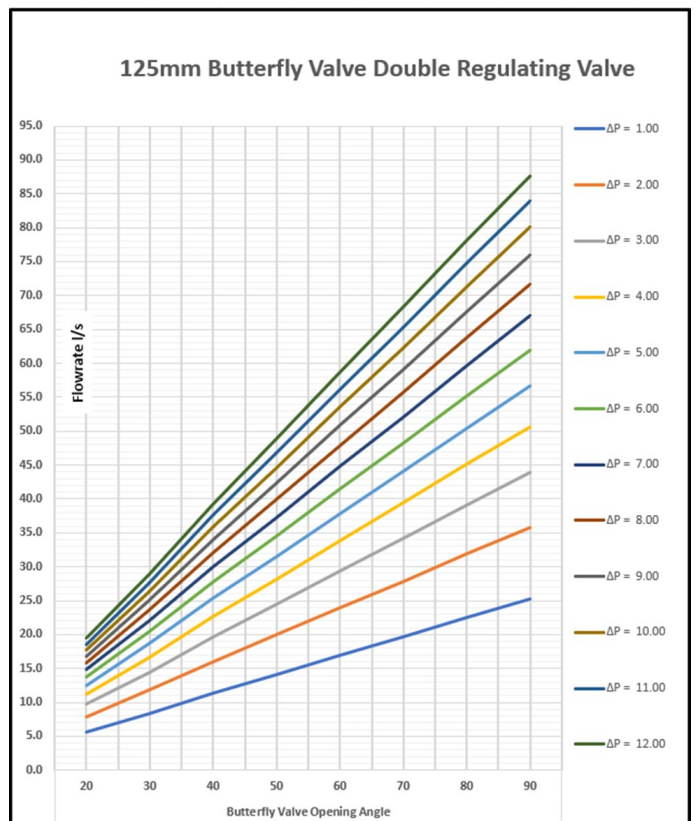
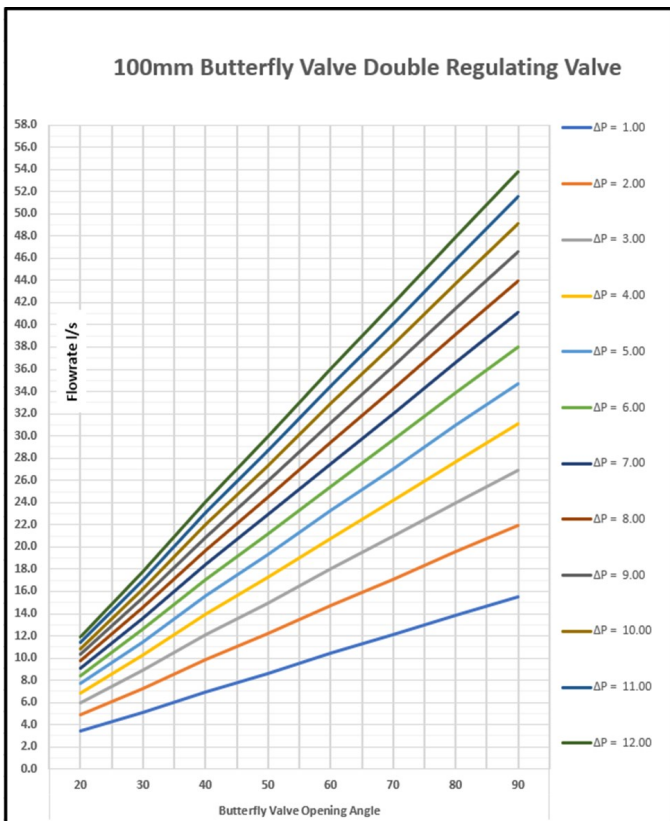

SELECTIONS

150mm Butterfly Valve Double Regulating Butterfly Valve
 Flow range: 10.0 – 135.0 l/s
 ΔP range: 1.0 – 12.0 Kpa

200mm Butterfly Valve Double Regulating Butterfly Valve
 Flow range: 15.0 – 255.0 l/s
 ΔP range: 1.0 – 12.0 Kpa

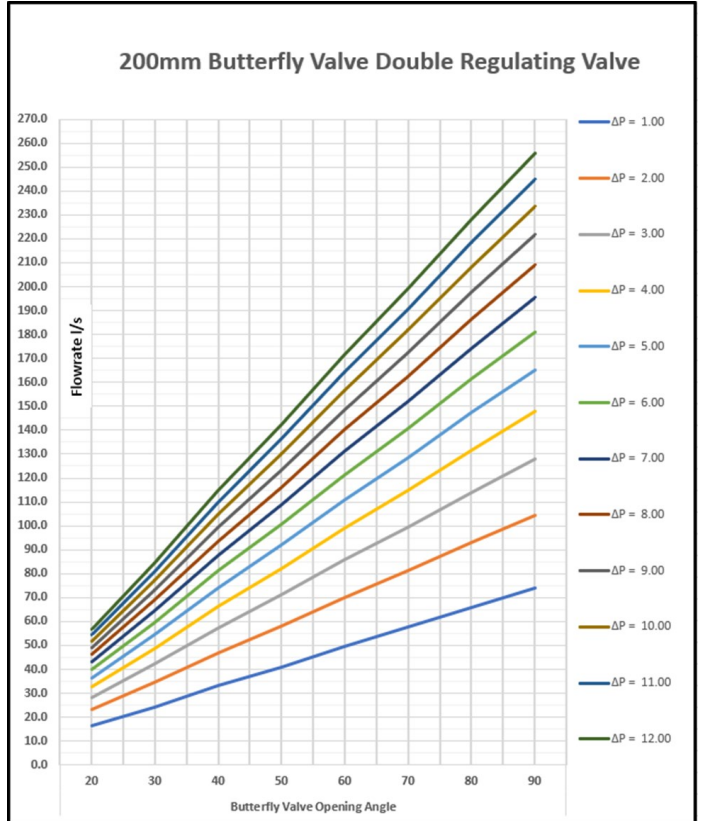
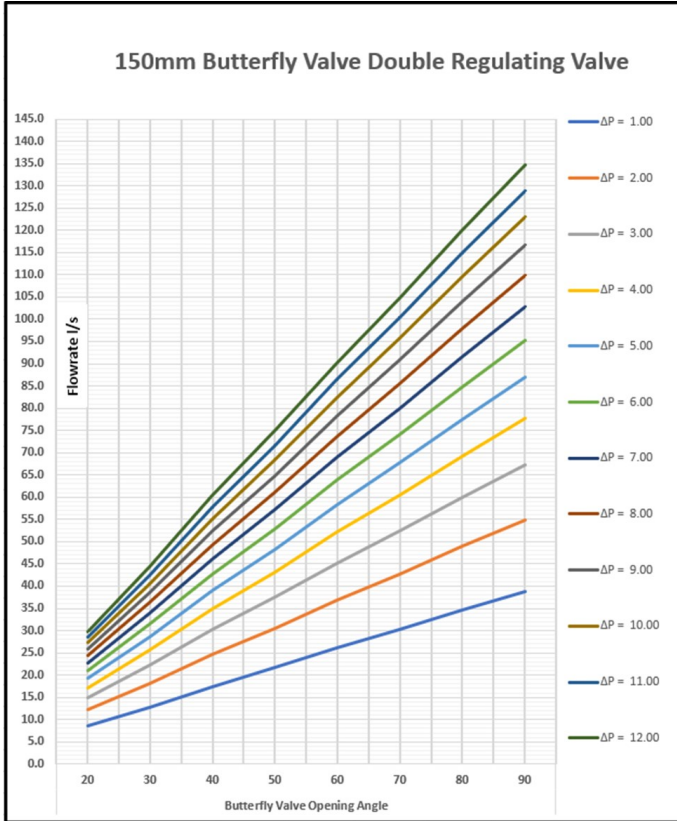

250mm Butterfly Valve Double Regulating Butterfly Valve
 Flow range: 25.0 – 400.0 l/s
 ΔP range: 1.0 – 12.0 Kpa

300mm Butterfly Valve Double Regulating Butterfly Valve
 Flow range: 45.0 – 625.0 l/s
 ΔP range: 1.0 – 12.0 Kpa

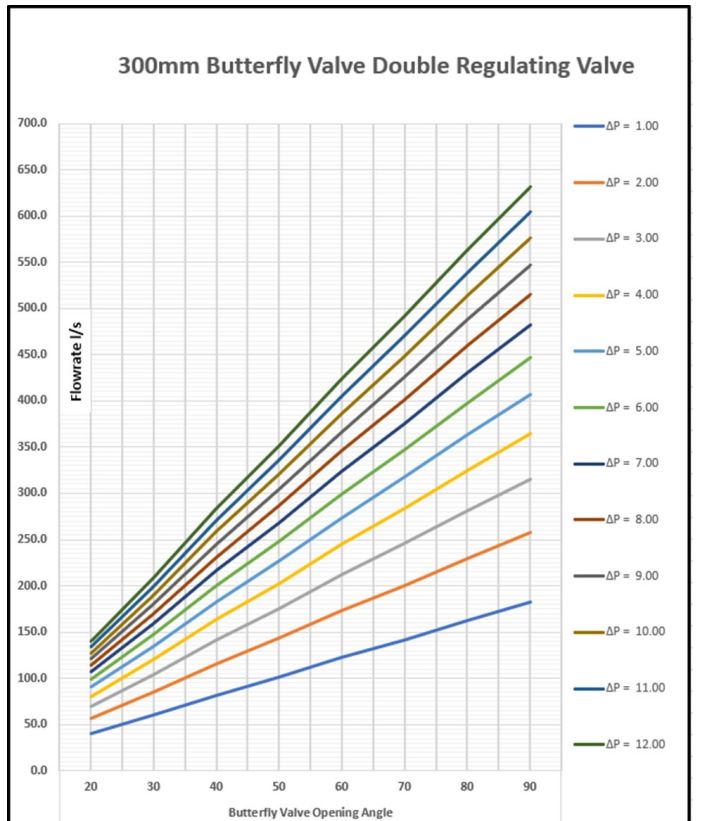
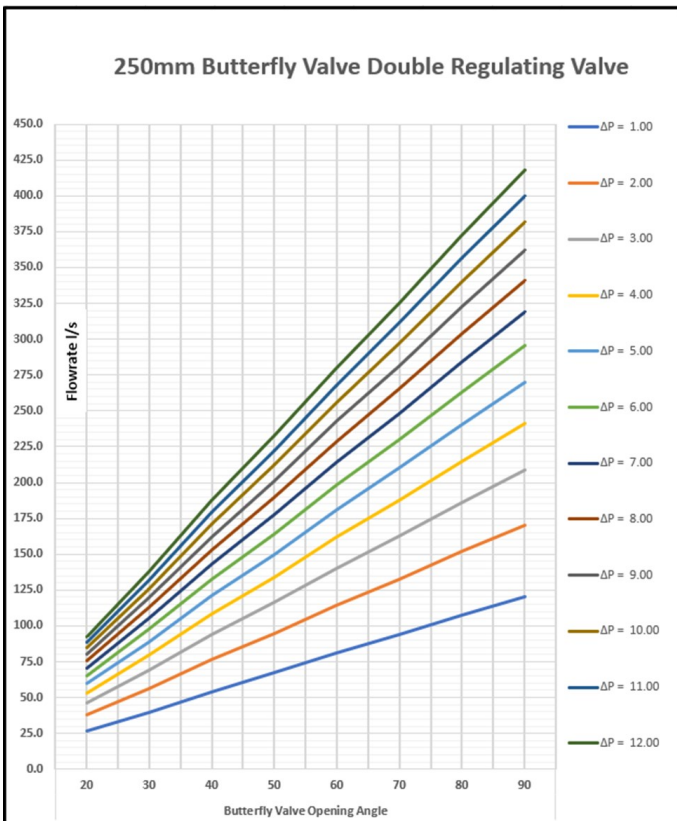

SELECTIONS

350mm Butterfly Valve Double Regulating Butterfly Valve
 Flow range: 50.0 – 900.0 l/s
 ΔP range: 1.0 – 12.0 Kpa

400mm Butterfly Valve Double Regulating Butterfly Valve
 Flow range: 100.0 – 1200.0 l/s
 ΔP range: 1.0 – 12.0 Kpa

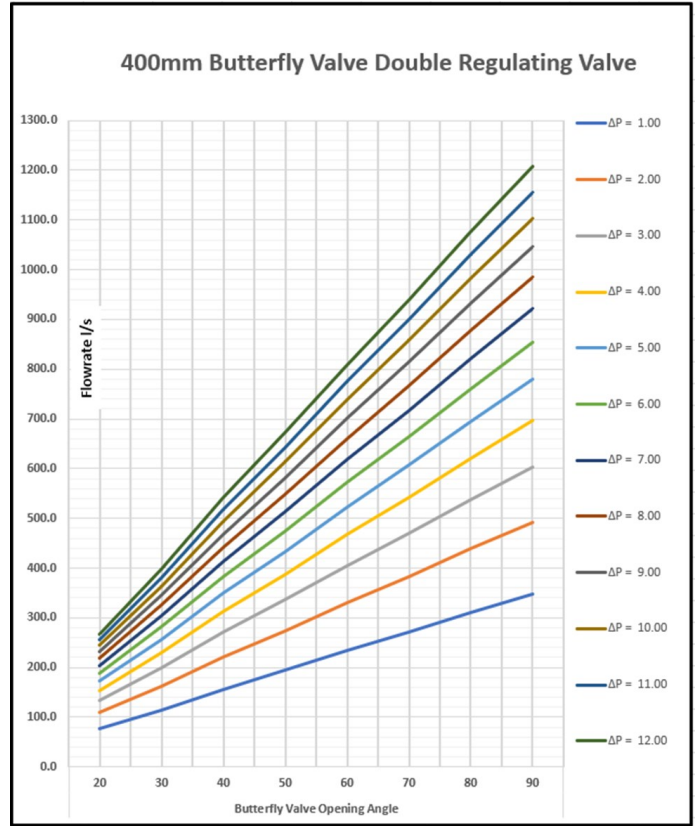
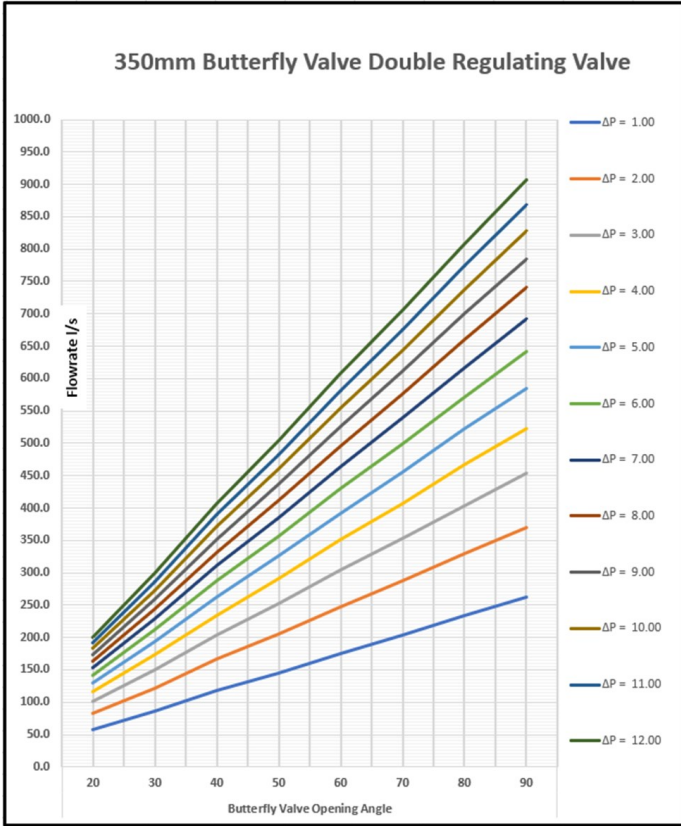

450mm Butterfly Valve Double Regulating Butterfly Valve
 Flow range: 100.0 – 1500.0 l/s
 ΔP range: 1.0 – 12.0 Kpa

500mm Butterfly Valve Double Regulating Butterfly Valve
 Flow range: 130.0 – 1900.0 l/s
 ΔP range: 1.0 – 12.0 Kpa

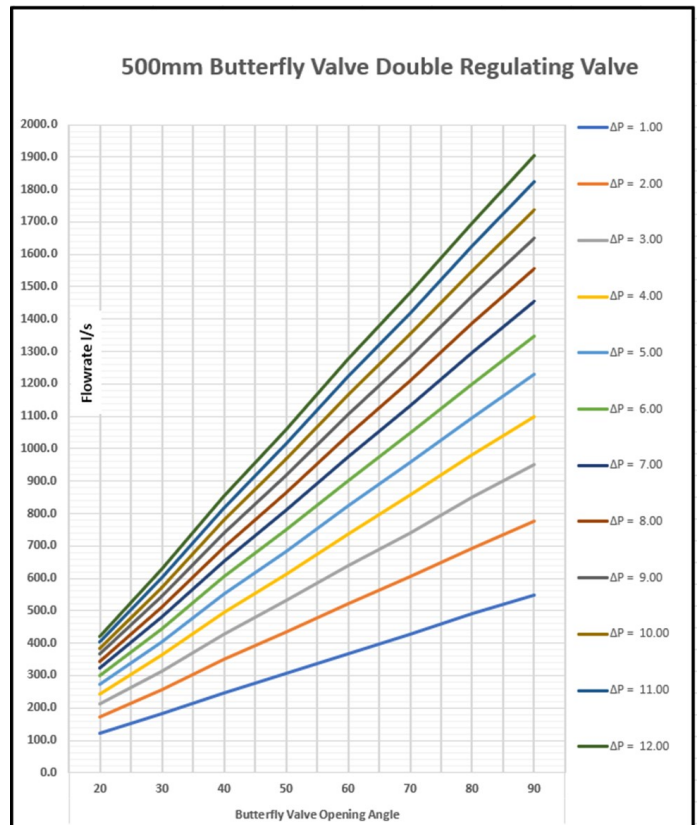
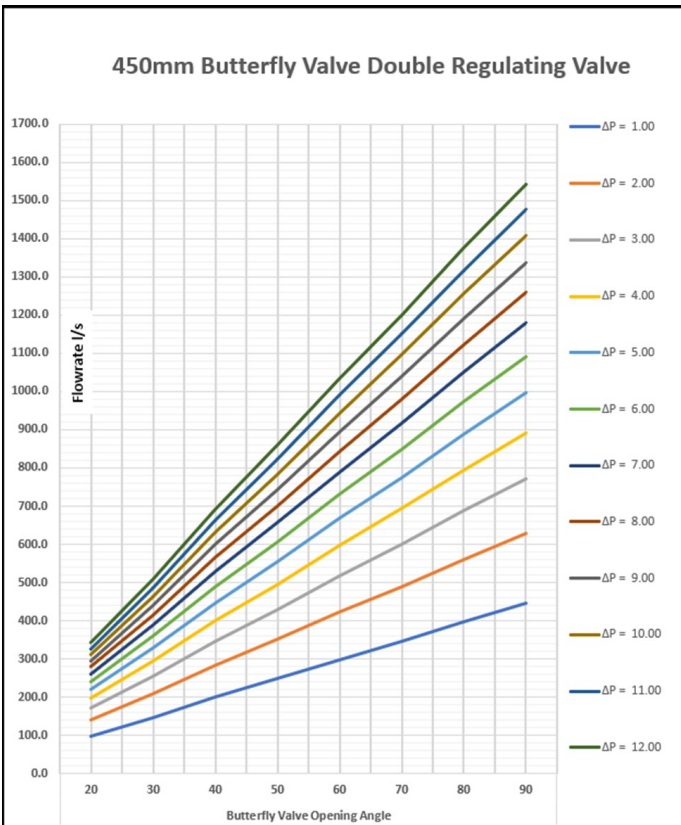

SELECTIONS

600mm Butterfly Valve Double Regulating Butterfly Valve

Flow range: 200.0 – 2800.0 l/s

ΔP range: 1.0 – 12.0 Kpa

